











fahrbar - mobile - mobile



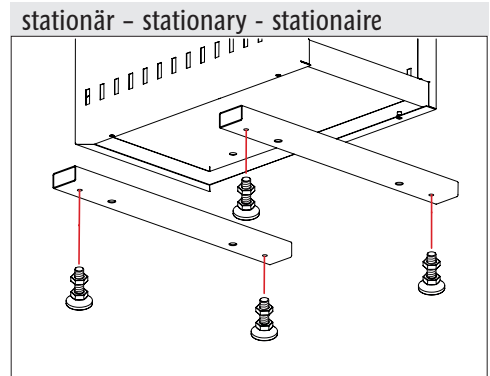

 SW 5	A	8x	M6x12 mm	
	B	4x	Stopfen	

 SW 8	C	2x/2x		
	D	4x		
	E	4x	M6x35 mm	
 SW 10	F	4x	M6	
	G	4x	M10x16 mm	

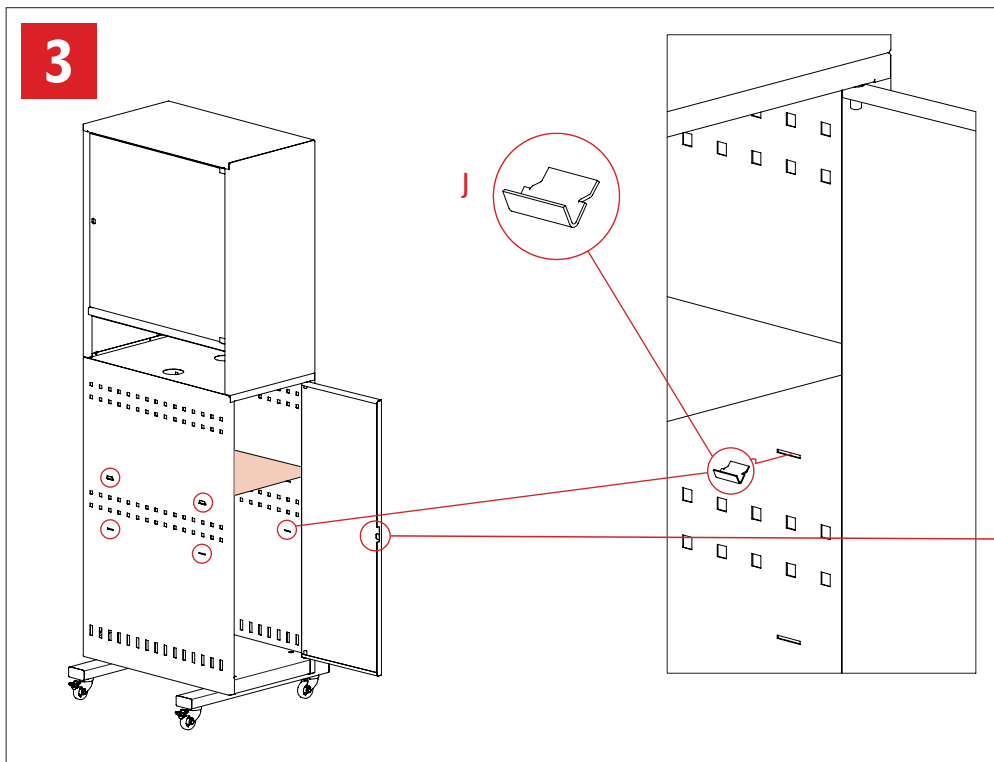
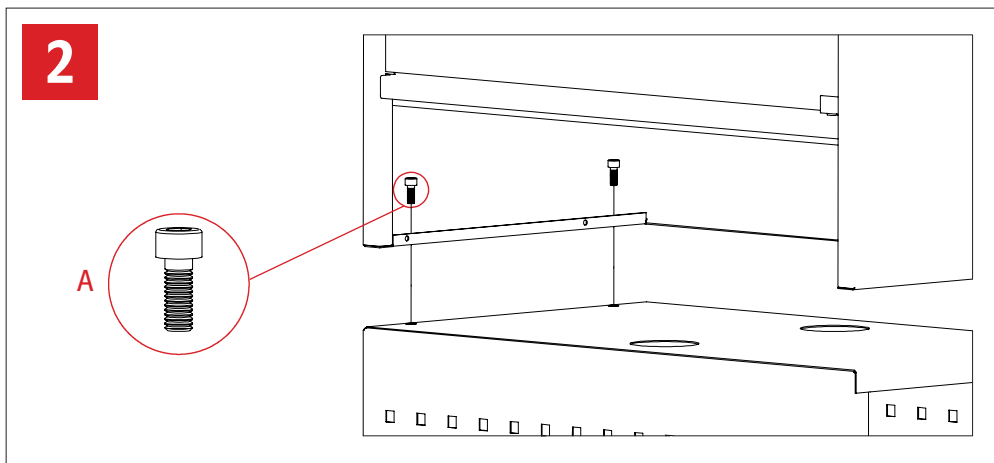

	C	4x		
--	---	----	--	---





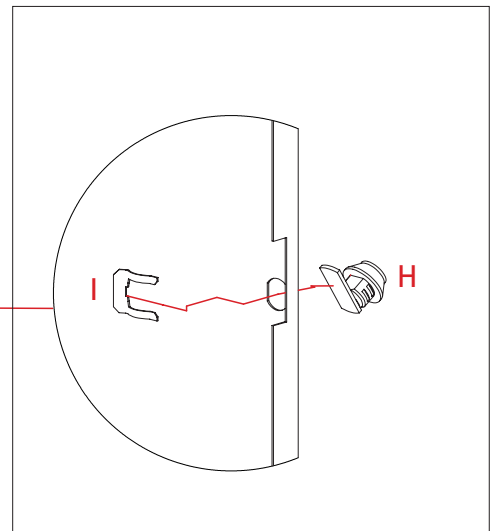



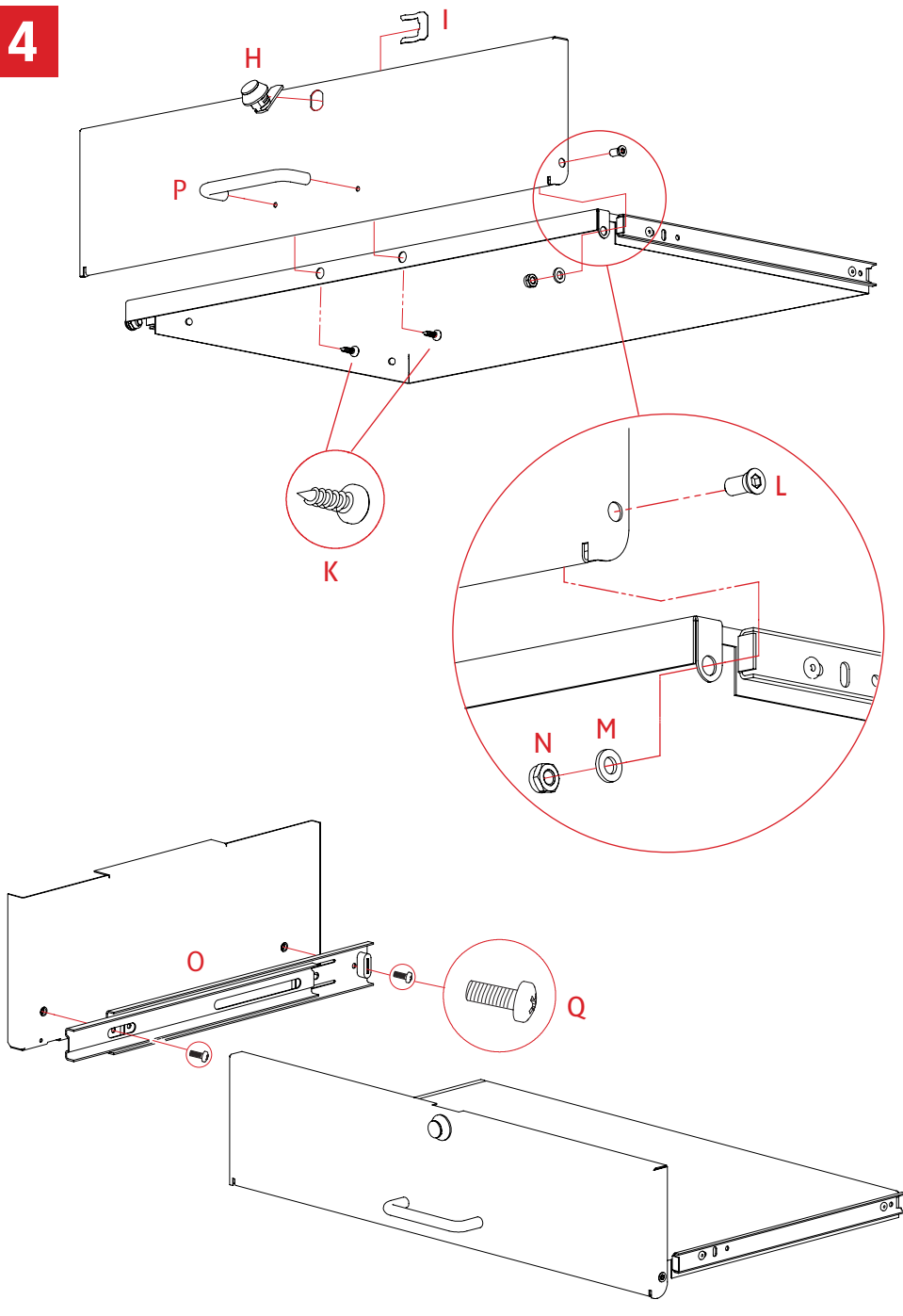







	H	1x		
	I	1x		
	J	4x		



4



 SW10	K	2x	Ø3,9x13 mm	
	L	2x	M6x9,5 mm	
 SW5	M	2x	Ø6,4 mm	
	H	2x		
 SW5	I	2x		
	N	2x	M6	
	O	2x		
	P	1x		
	Q	4x	M6 x12 mm	
	R	4x	ST3,5x9,5 mm	

6

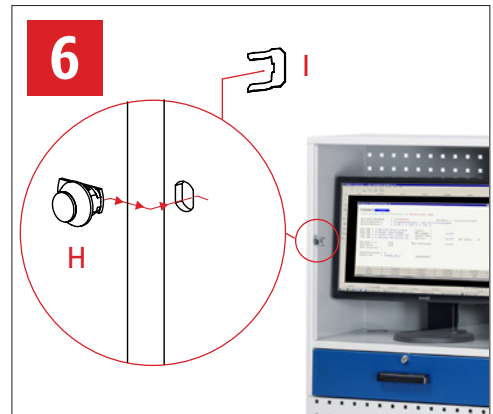

5

