







**1**



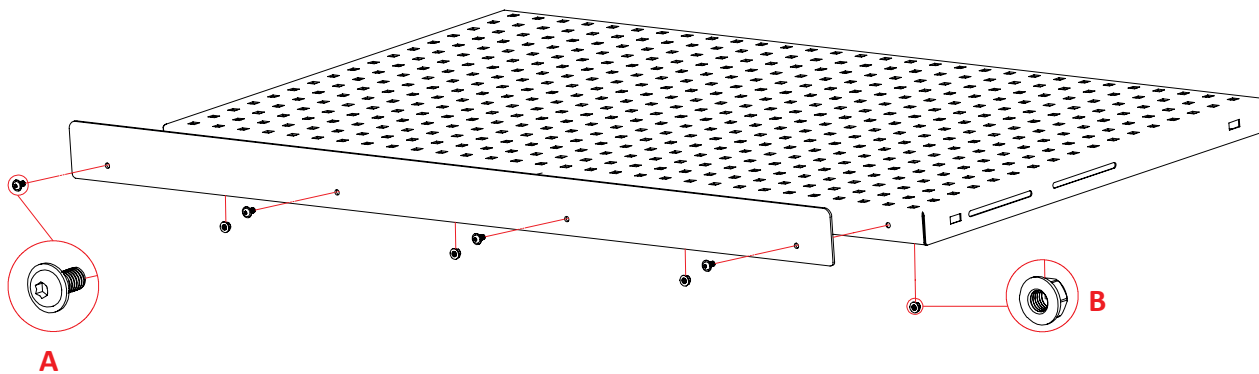

	<b>A</b>	<b>4x</b>	M6x12	
	<b>B</b>	<b>4x</b>	M6	

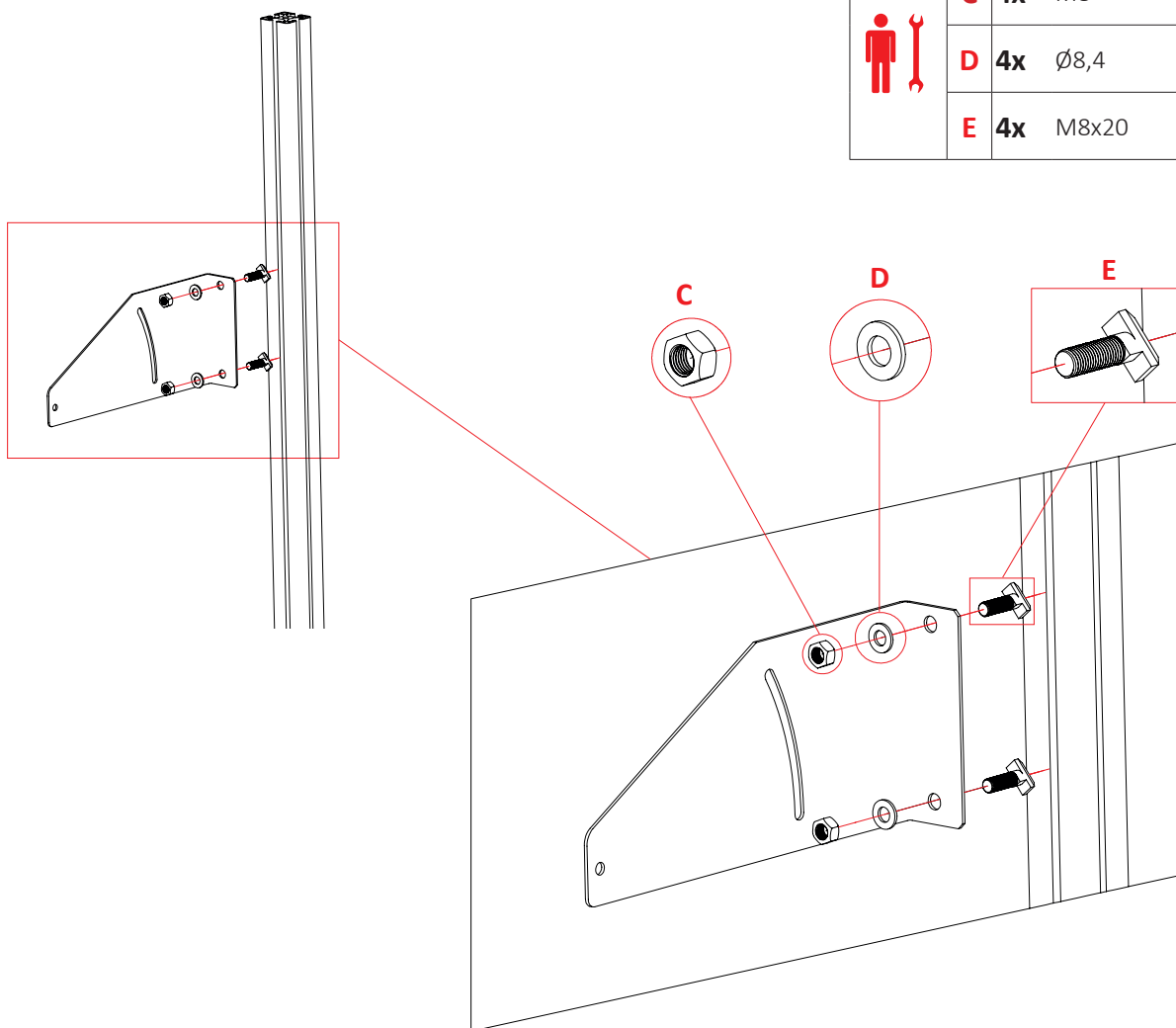
**2**

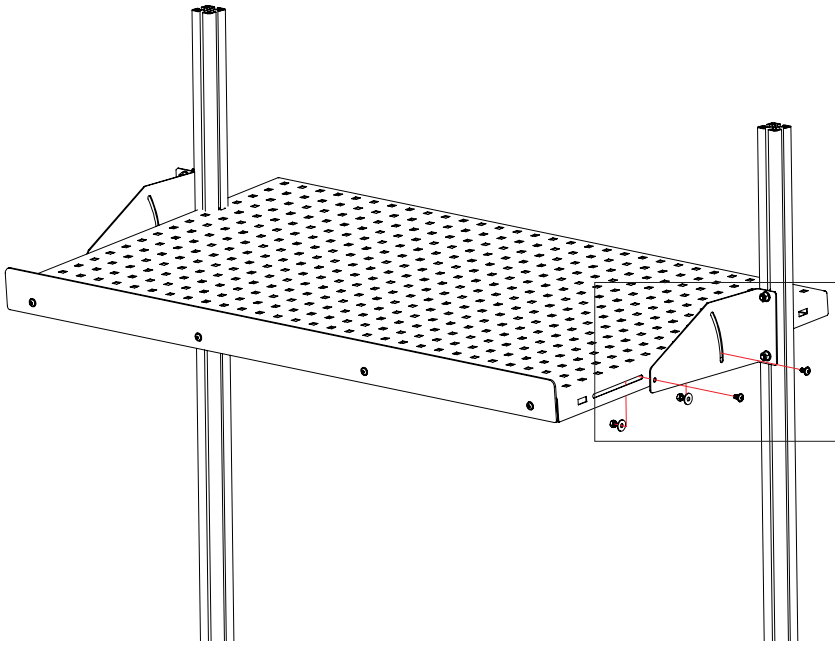

	<b>C</b>	<b>4x</b>	M8	
	<b>D</b>	<b>4x</b>	Ø8,4	
	<b>E</b>	<b>4x</b>	M8x20	

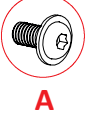
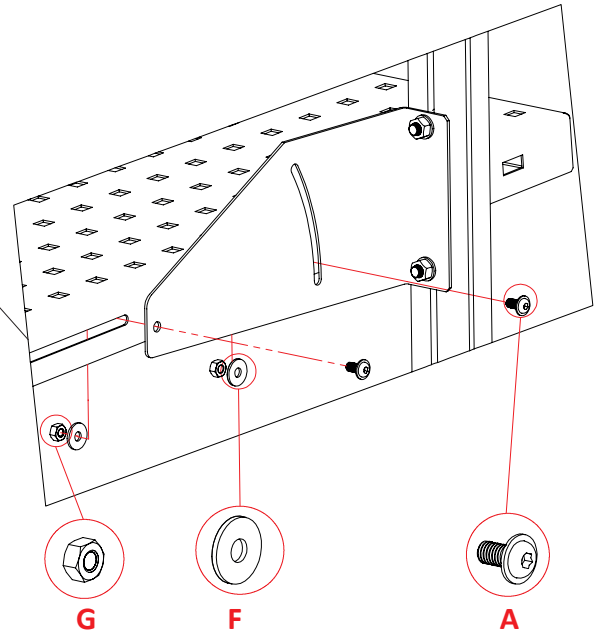
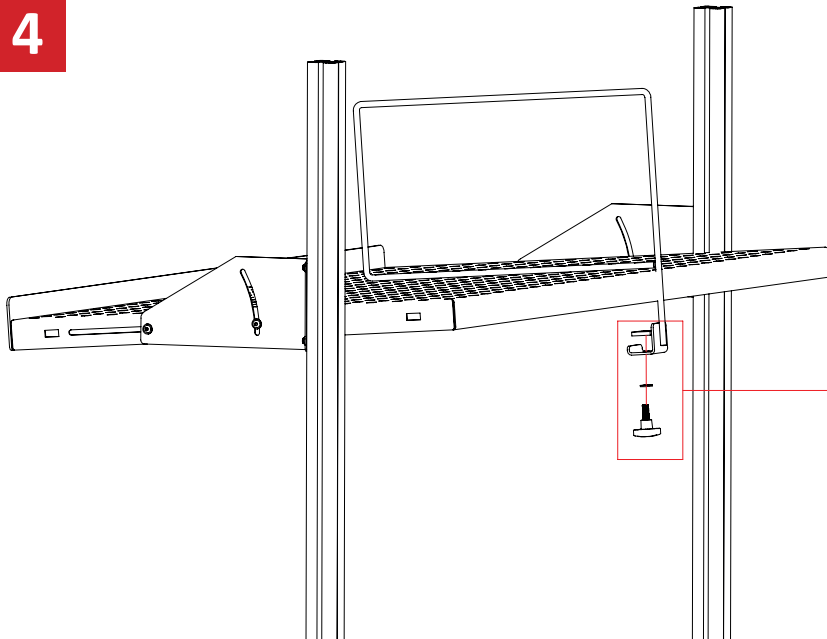

**3**

	<b>A</b> 4x M6x12	
	<b>F</b> 4x $\varnothing 6,4, \varnothing 18$	
	<b>G</b> 4x M6	

**4**

	<b>H</b> 1x M8	
	<b>I</b> 1x $\varnothing 8,4$	

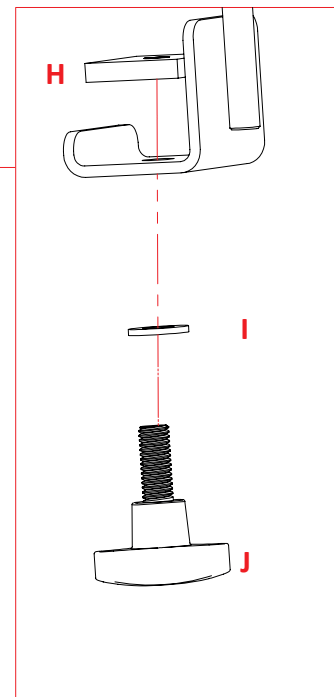
**H****I****J**

